

PC170 Control Box

24V DC GEAR MOTOR

FOR RESIDENTIAL
USER MANUAL

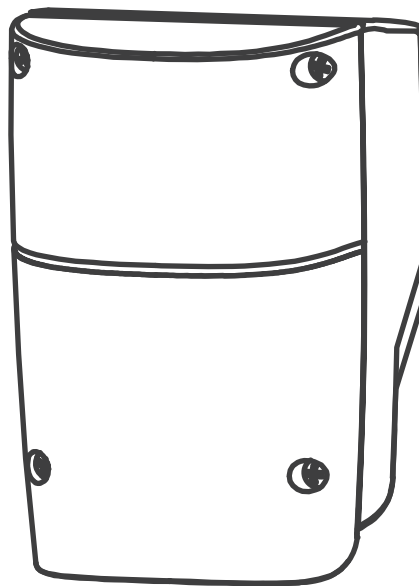

INDEX

| | | |
|------------|--|----------|
| 1. | CONTROL BOX | 1 |
| 2. | SETTING | 3 |
| 2.1 | SW1 DIP SWITCH SETTING | 3 |
| 2.1.1 | SLOWDOWN ADJUSTMENT (DIP 1. SLOW) | 3 |
| 2.1.2 | OVER-CURRENT ADJUSTMENT (DIP 2.OVER C1 & DIP 3.OVER C2) | 3 |
| 2.1.3 | GATE AUTO-CLOSE ADJUSTMENT (DIP 4.AUTO C1, DIP 5.AUTO C2 & DIP 6.AUTO C3) | 3 |
| 2.1.4 | PEDESTRIAN MODE ADJUSTMENT (DIP 7.P MODE) | 4 |
| 2.1.5 | FLASHING LIGHT ADJUSTMENT (DIP 8.LIGHT) | 4 |
| 2.2 | SW2 DIP SWITCH SETTING | 4 |
| 2.2.1 | PHOTOCELLADJUSTMENT (DIP 1.PHOTO1, DIP 2.PHOTO2) | 4 |
| 2.2.2 | CLOSE DELAY OF DUAL GATE OPERATION ADJUSTMENT (DIP 3.DELAY1, DIP 4.DELAY2) | 5 |
| 2.2.3 | ELECTRIC LATCH ADJUSTMENT (DIP 5.LATCH) | 5 |
| 2.2.4 | DECELERATION SPEED ADJUSTMENT OF THE GEAR MOTORS (DIP 6. D SPEED) | 5 |
| 2.2.5 | OPERATION SPEED ADJUSTMENT OF THE GEAR MOTORS (DIP 7. O SPEED) | 5 |
| 2.2.6 | SINGLE AND DUAL GATE OPERATION ADJUSTMENT (DIP 8.DS/SET) | 5 |
| 2.3 | LED INDICATION | 5 |
| 2.4 | TRANSMITTER MEMORIZE | 6 |
| 2.5 | SYSTEM LEARNING PROCESS | 6 |
| 2.6 | GATE OPERATION (Optional) | 7 |
| 2.7 | GATE-MOVING LOGIC | 7 |
| 2.8 | ADVANCED OPERATION OF THE TRANSMITTER | 7 |
| 3. | TROUBLE SHOOTING | 8 |
| 4. | PHOTOCELL INSTALLATION GUIDE | 9 |

1. CONTROL BOX

CONTROL BOX INSTALLATION

1. Decide the installation position of control box first, it is suggested to be installed near the gate and should be protected from possible damage. Be aware of the motor cable length before deciding the installation position.
2. Remove the cover by unscrewing the four screws on the cover. See Figure 1(1).
3. Use a screwdriver to puncture the holes beneath the bottom of the control box. See Figure 1(2).
4. Secure it on the wall. See Figure 1(3).

Figure 1(1)

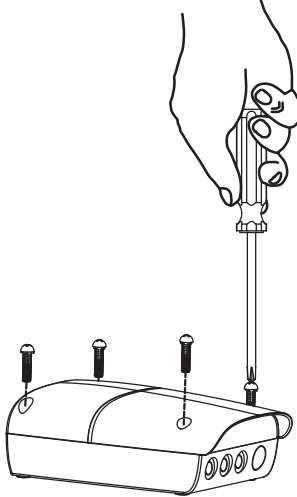

Figure 1(2)

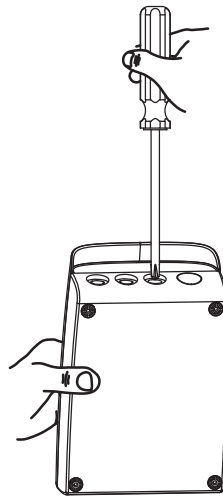
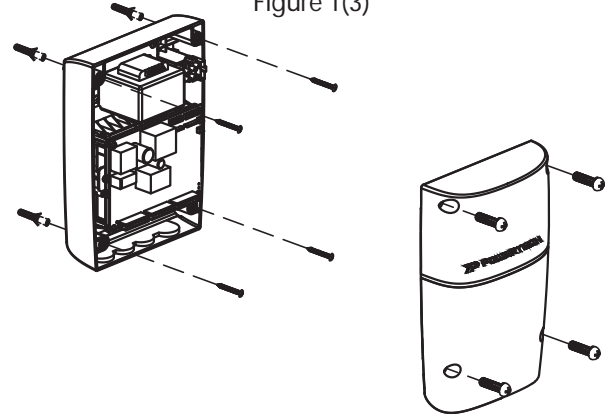

Figure 1(3)



5. Wiring Connection:

Prepare all the wires of the accessories beforehand and connect the wires to the gear motors and accessories on the PCB as shown in Figure 1(4). All of the wiring connections of the accessories are not requested to distinguish the positive (+) and the negative (-) polarity.

- 1). Flashing Light: Connect the two wires from the flashing light to the terminal L+ and L- on the PCB.
- 2). Electric Latch: Connect the two wires from the electric latch to the terminal Lo + and Lo- on the PCB.
- 3). Gate openers: Refer to Figure 1(4) and connect the wires separately to the terminals on the PCB.

Motor 1: Connect the motor wire (White +) to the terminals Mo1 +, and (Yellow -) to the Mo1-.

Motor 2: Connect the motor wire (White +) to the terminals Mo2 +, and (Yellow -) to the Mo2 -.

Notes:

For gates opened outward,

Motor 1: Connect the motor wire (Yellow -) to the terminals Mo1 +, and (White +) to the terminals Mo1-.

Motor 2: Connect the motor wire (Yellow -) to the terminals Mo2 +, and (White +) to the terminals Mo2 -.

4). Photocells: See Figure 1(4)

(A) installed one set Photocell to FO1, SW3 setting as below:

3. Ph_conn1 > OFF and 4. Ph_conn2 > ON

(B) installed one set Photocell to FO2, SW3 setting as below:

3. Ph_conn1 > ON and 4. Ph_conn2 > OFF

(C) installed two sets Photocell, SW3 setting as below:

3. Ph_conn1 > OFF and 4. Ph_conn2 > OFF

(D) No Photocell has been installed, SW3 setting as below:

3. Ph_conn1 > ON and 4. Ph_conn2 > ON

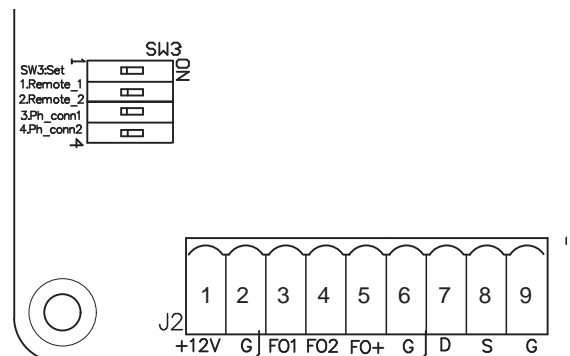
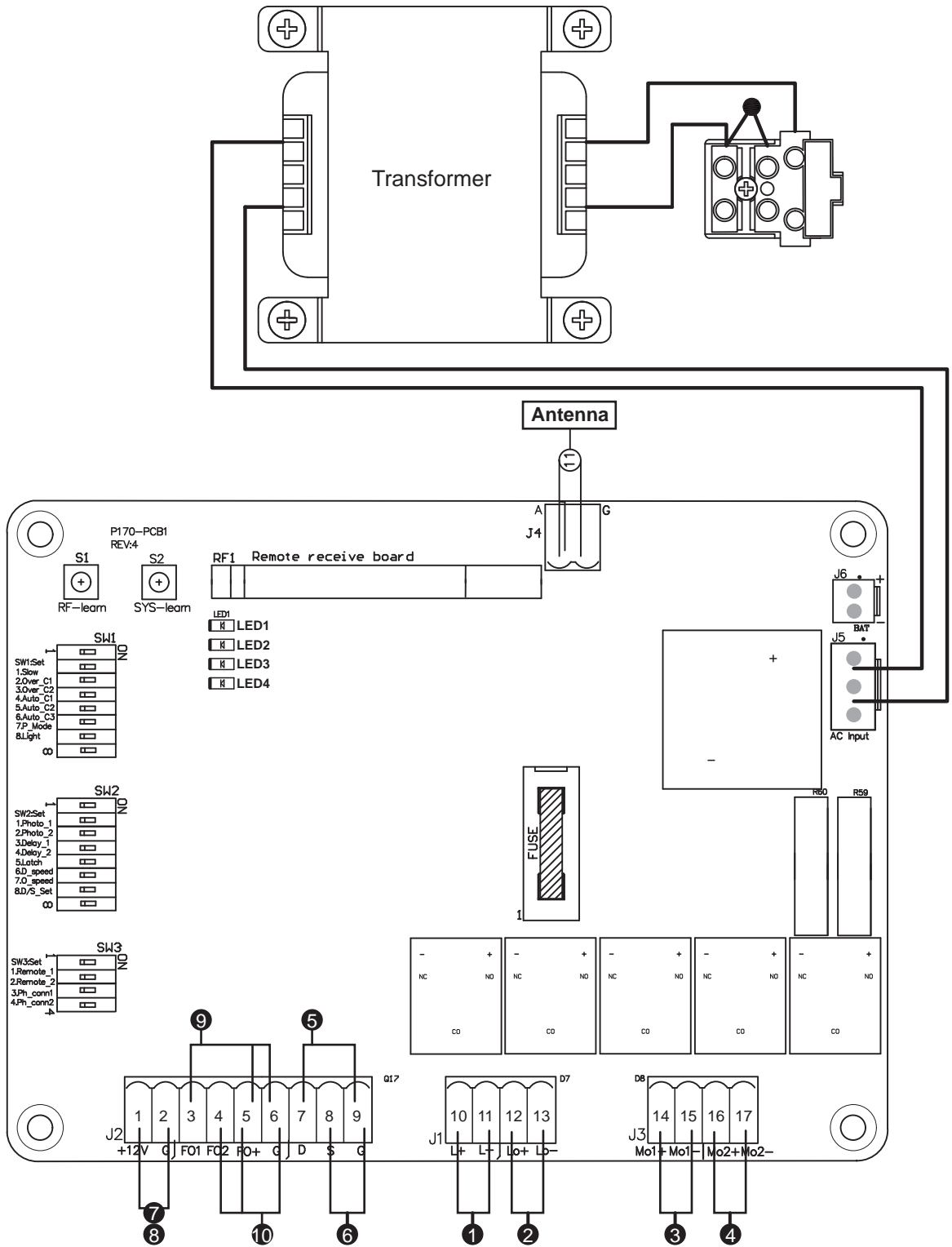

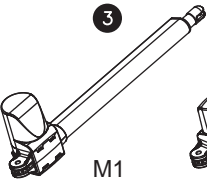
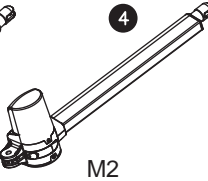







Figure 1(4)



- 1

- 2

- 3

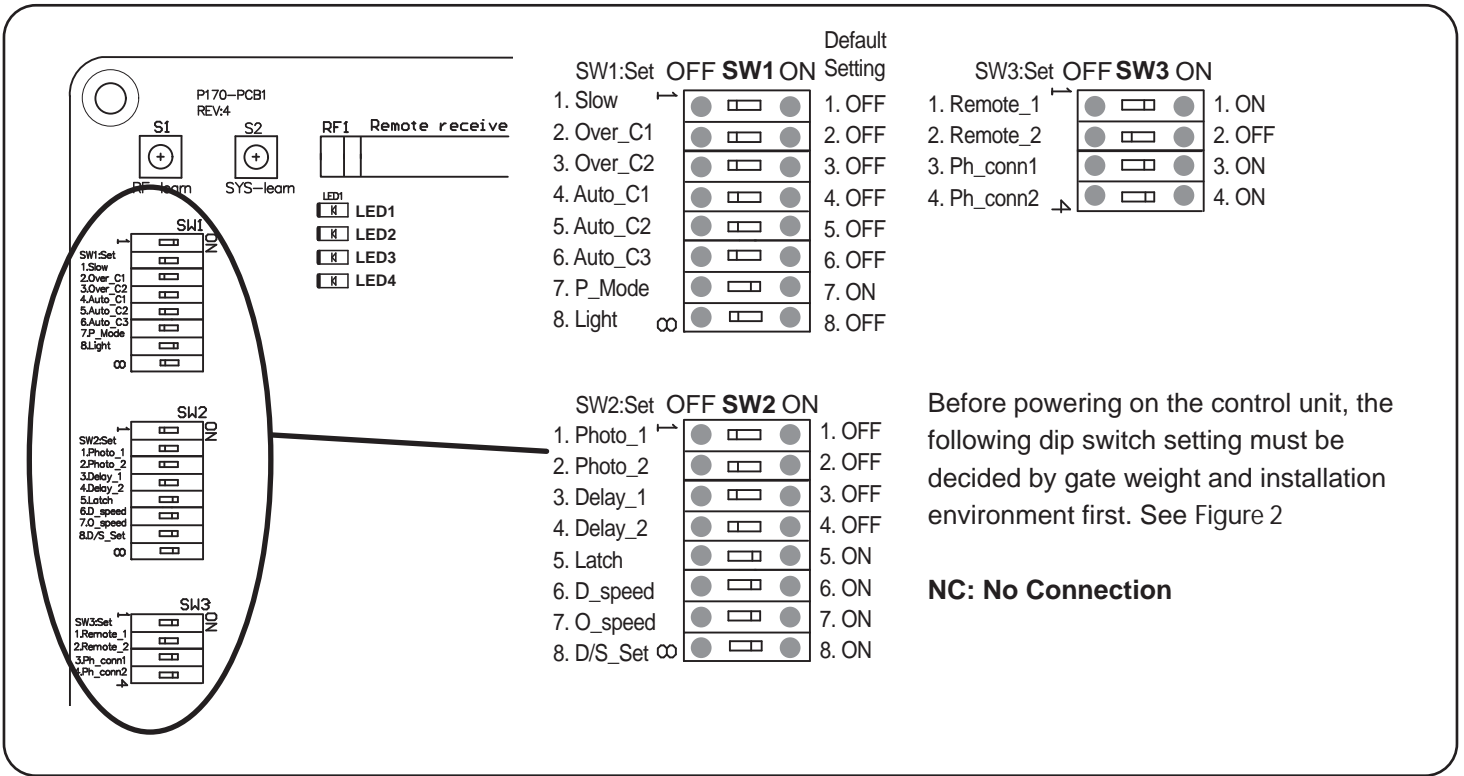
- 4

- 5

- 6

- 7

- 8

- 9

- 10

Flashing Light

2). SETTING



2.1 SW1 DIP SWITCH SETTING

2.1.1 SLOWDOWN ADJUSTMENT (DIP 1.SLOW)

ON: The gear motors do not slow down before the gates completely close or open.
 OFF: The gear motors slow down before the gates completely close or open.

2.1.2 OVER-CURRENT ADJUSTMENT (DIP 2.OVER C1 & DIP 3.OVER C2)

| OVER C1 | OVER C2 | Current (Amp) |
|------------------|------------------|---------------|
| Dip Switch 2 OFF | Dip Switch 3 OFF | 2A |
| Dip Switch 2 OFF | Dip Switch 3 ON | 3A |
| Dip Switch 2 ON | Dip Switch 3 OFF | 4A |
| Dip Switch 2 ON | Dip Switch 3 ON | 5A |

2.1.3 GATE AUTO-CLOSE ADJUSTMENT (DIP 4.AUTO C1, DIP 5.AUTO C2 & DIP 6.AUTO C3)

| Auto C1 | Auto C2 | Auto C3 | Effect |
|------------------|------------------|------------------|---------------|
| Dip switch 4 OFF | Dip Switch 5 OFF | Dip Switch 6 OFF | No auto-close |
| Dip switch 4 OFF | Dip Switch 5 OFF | Dip Switch 6 ON | 3 sec. |
| Dip switch 4 OFF | Dip Switch 5 ON | Dip Switch 6 OFF | 10 sec. |
| Dip switch 4 OFF | Dip Switch 5 ON | Dip Switch 6 ON | 20 sec. |
| Dip switch 4 ON | Dip Switch 5 OFF | Dip Switch 6 OFF | 40 sec. |
| Dip switch 4 ON | Dip Switch 5 OFF | Dip Switch 6 ON | 60 sec. |
| Dip switch 4 ON | Dip Switch 5 ON | Dip Switch 6 OFF | 120 sec. |
| Dip switch 4 ON | Dip Switch 5 ON | Dip Switch 6 ON | 360 sec. |

Note: Auto-close mode activates when the gates move to the end position or stopped manually. If the transmitter, push button, or the key selector is activated before the auto-close counting, the gate will close immediately.

2.1.4 PEDESTRIAN MODE ADJUSTMENT (DIP 7.P MODE)

ON: Press button B on the remote to operate to pedestrian mode by open single gate to 45 degree

OFF: The pedestrian mode is disabled. Single gate will fully open and close

2.1.5 FLASHING LIGHT ADJUSTMENT (DIP 8.LIGHT)

ON: The flashing light blinks for 3 seconds before the gate moves, and blinks simultaneously during the movement.

OFF: The flashing light blinks and the gate moves simultaneously.

2.2 SW2 DIP SWITCH SETTING

2.2.1 PHOTOCELL ADJUSTMENT (DIP 1.PHOTO1, DIP 2.PHOTO2)

1. SW2_2, SW2_1: OFF OFF

| Position of Gate | When safety devices are activated | |
|-----------------------|------------------------------------|-------------------------------------|
| Type of Safety Device | Safety Device2 : Photocell-OPEN | Safety Device1 : Photocell-CLOSE |
| FULLY CLOSED | Open not allowed | No effect |
| FULLY OPENED | No effect | Reload automatic closing time |
| STOP DURING MOVING | Open not allowed | Reload automatic closing time |
| CLOSING | No effect | Open |
| OPENING | Close | No effect |

2. SW2_2, SW2_1: OFF ON

| Position of Gate | When safety devices are activated | |
|-----------------------|-----------------------------------|-------------------------------------|
| Type of Safety Device | Safety Device2 : Safety Edge | Safety Device1 : Photocell-CLOSE |
| FULLY CLOSED | Open not allowed | No effect |
| FULLY OPENED | Reload automatic closing time | |
| STOP DURING MOVING | Locks | Reload automatic closing time |
| CLOSING | Reverse to open for 2 seconds | Open |
| OPENING | Reverse to close for 2 seconds | No effect |

3. SW2_2, SW2_1: ON OFF

| Position of Gate | When safety devices are activated | |
|-----------------------|------------------------------------|-------------------------------------|
| Type of Safety Device | Safety Device2 : Opening Device | Safety Device1 : Photocell-CLOSE |
| FULLY CLOSED | Open | No effect |
| FULLY OPENED | Reload automatic closing time | |
| STOP DURING MOVING | Open | Reload automatic closing time |
| CLOSING | Open | Open |
| OPENING | No effect | No effect |

4. SW2_2, SW2_1: ON ON

| Position of Gate | When safety devices are activated | |
|-----------------------|---|-------------------------------------|
| Type of Safety Device | Safety Device2 : Photocell-OPEN/CLOSE | Safety Device1 : Photocell-CLOSE |
| FULLY CLOSED | Open not allowed | No effect |
| FULLY OPENED | Close not allowed, Open for 2 seconds when auto closing is ON | |
| STOP DURING MOVING | Locks | Close not allowed |
| CLOSING | Stop | Open |
| OPENING | Stop | No effect |

2.2.2 CLOSE DELAY OF DUAL GATE OPERATION ADJUSTMENT (DIP 3.DELAY1, DIP 4.DELAY2)

Close/Open delay of two leaves of gate can be adjusted from 2 to 6 seconds

| DIP switch | | Open Delay | Close Delay |
|---------------|---------------|------------|-------------|
| Dip3. Delay 1 | Dip4. Delay 2 | | |
| OFF | OFF | 2 sec | 3 sec |
| ON | OFF | 2 sec | 4 sec |
| OFF | ON | 3 sec | 5 sec |
| ON | ON | 3 sec | 6 sec |

2.2.3 ELECTRIC LATCH ADJUSTMENT (DIP 5.LATCH)

ON: The master leaf will move toward closing direction for 0.25 second once command the remote, then unlock the latch to open the gate.

OFF: Once command the remote, the the latch will be unlocked to open the gate immediately

2.2.4 DECELARATION SPEED ADJUSTMENT OF THE GEAR MOTORS (DIP 6. D SPEED)

ON: The speed is 70% output of the full speed.

OFF: The speed is 50% output of the full speed.

2.2.5 OPERATION SPEED ADJUSTMENT OF THE GEAR MOTORS (DIP 7.O SPEED)

ON: The speed is 100% output of the full speed.

OFF: The speed is 70% output of the full speed.

2.2.6 SINGLE AND DUAL GATE OPERATION ADJUSTMENT (DIP 8.DS/SET)

ON: Dual Gates operation in system learning and normal operation.

OFF: Single Gate operation in system learning and normal operation.

2.3 LED INDICATION

LED1 System Learning: LED1 is always ON when the system learning in not completed.

LED1 blinks once when single-gate learning is completed ;

LED1 blinks twice when dual-gate learning is completed.

LED2 RF : If the switch of the transmitter, key selector, or the push button is activated, LED2 will be on.

LED3 Photocells 1 : LED3 will be on when the first pair of the photocells are activated.

LED4 Photocells 2 : LED4 will be on when the second pair of the photocells are activated.

LED5 RF Indicator : LED5 will be on when RF signal is received.

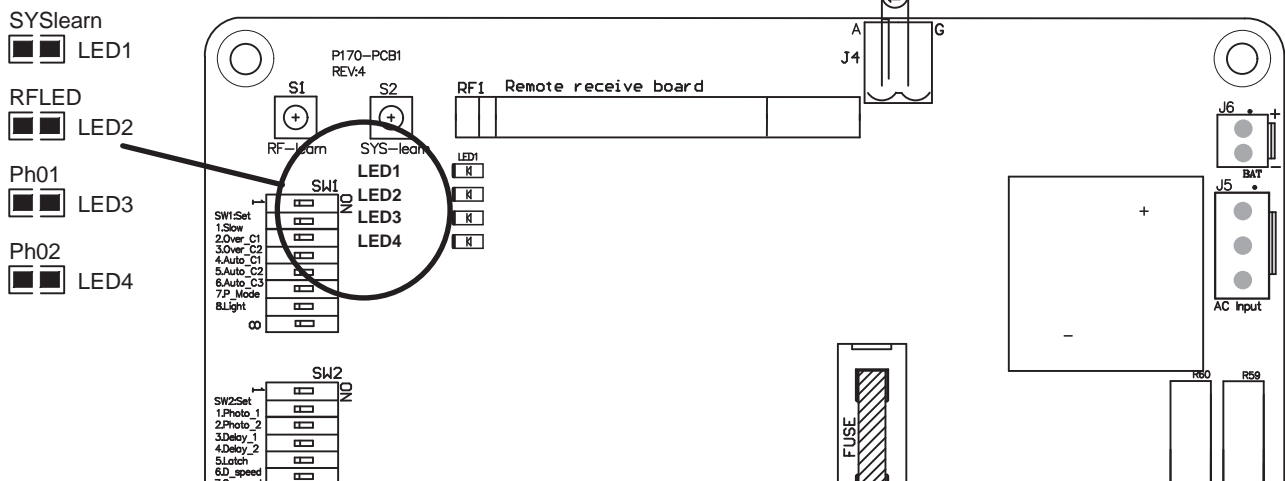

2.4 TRANSMITTER MEMORIZING PROCESS

Press “RF-learn” button for 2 seconds, and the Blue LED is on; then press the transmitter (A) button; the Blue LED will blink twice and then be off. The system learning is complete.

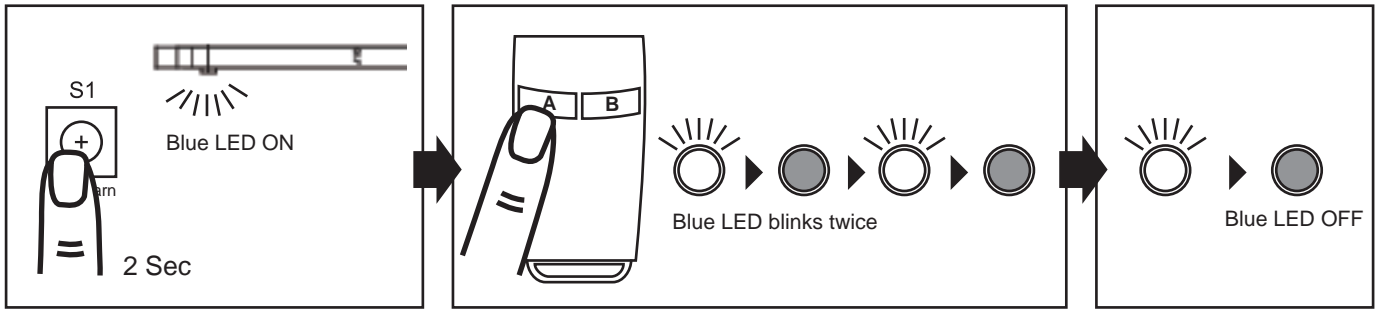

2.5 SYSTEM LEARNING PROCESS

! CAUTION: Before proceeding to system learning, the transmitter memorizing process has to be completed.

Press “SYS-learn” button for 2 seconds, after press button (A) on the remote. System learning will be executed step by step as followings: Wait for the learning process to be completed without any interruption.

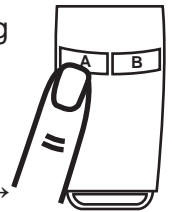

A. Dual Gate:

- ① Slave Gate Close → ② Master Gate Close → ③ Master Gate Open → ④ Slave Gate Open → ⑤ Slave Gate Close → ⑥ Master Gate Close

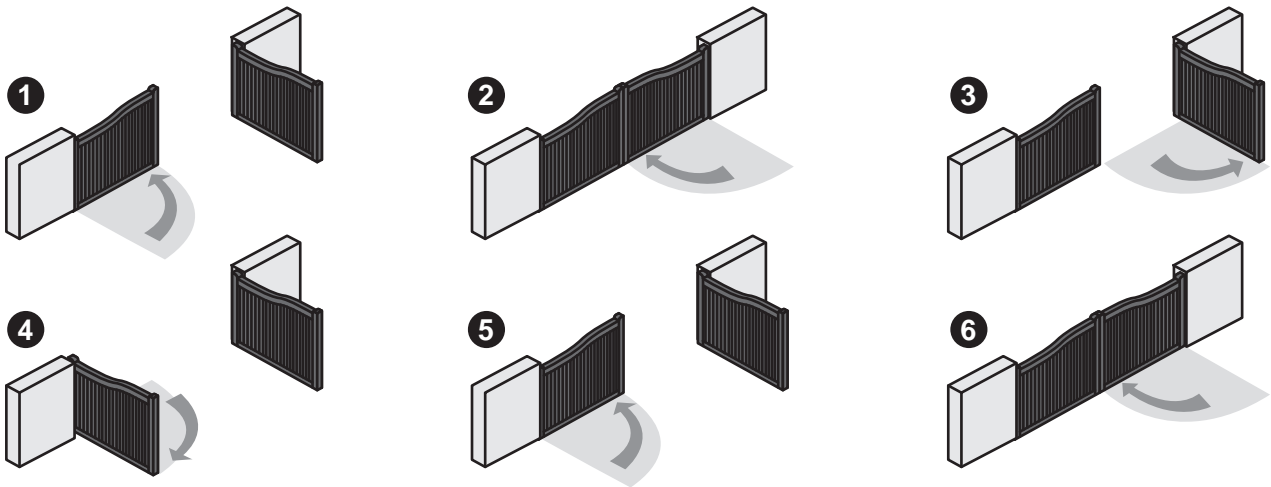

B. Single Gate :

- ① Master Gate Close → ② Master Gate Open → ③ Master Gate Close

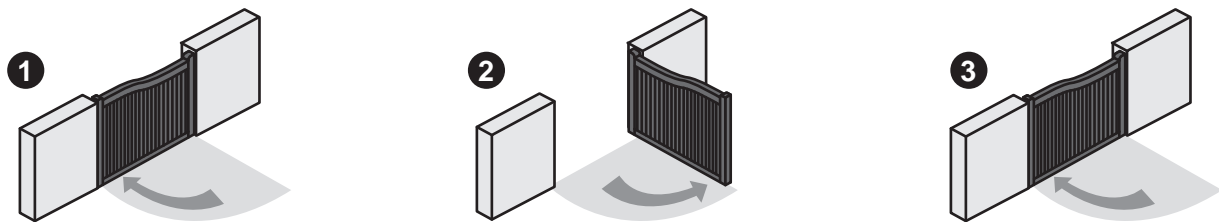

! Beware: The system learning process for single gate takes more than dual gate for around 1 min, wait for the gate to complete the learning process.

2.6 GATE OPERATION

Press the button “A” on the transmitter for dual-gate operation.

Press the button “B” on the transmitter for single-gate operation in either single-gate or dual-gate installation.

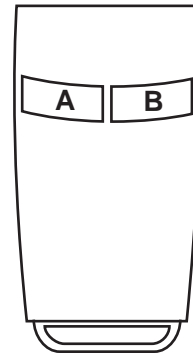

2.7 GATE-MOVING LOGIC

- (A) In gate-opening phase: The gates stop if the transmitter/push button/key selector is activated, and close when the transmitter/push button/key selector is reactivated.
- (B) In gate-closing phase: The gates stop if the transmitter/push button/key selector is activated, and open when the transmitter/push button/key selector is reactivated.
- (C) In gate-opening or gate-closing phase: For safety purpose, the gates stop if encountering obstacles.

2.8 ADVANCED OPERATION OF THE TRANSMITTER (SW3 DIP1/2 REMOTE 1 & REMOTE2)

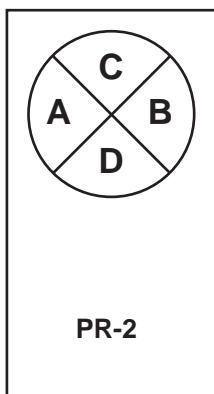

See the following description:

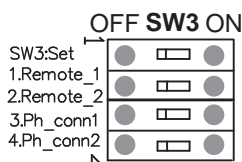

A.PR-1/PR-2

Situation 1: Dip1. Remote 1:ON & Dip2. Remote 2:ON

Transmitter button A for single leaf operation.
Transmitter button B for double leaves operation.

Situation 2: Dip1. Remote 1:ON & Dip2. Remote 2:OFF

Transmitter button B for single leaf operation.
Transmitter button A for double leaves operation.

B.PR-2 Extensive (Optional)

Situation 3: Dip1. Remote 1:OFF & Dip2. Remote 2:ON

Transmitter button C for single leaf operation.
Transmitter button D for double leaves operation.

Situation 4: Dip1. Remote 1:OFF & Dip2. Remote 2:OFF

Transmitter button D for single leaf operation.
Transmitter button C for double leaves operation.

3. TROUBLE SHOOTING

| | |
|--|---|
| Overheated Back-up Batteries | Check the wiring connection of the batteries. |
| The gate doesn't move when pressing the button of the transmitter | <ol style="list-style-type: none"> 1. Check if LED3 or 4 is "ON". 2. Check if the voltage of the batteries is below 22V. 3. Check if LED1 is "ON". 4. Make sure all the wiring connections are firmly connected to the terminals on the PCB. 5. Make sure the fuse is workable. |
| The gate only moves a little distance when pressing the button of the transmitter. | Make sure the wiring connection of the hall sensor is firm. |
| The transmitting distance is too short | Make sure the connecting terminals of the Antenna is firm. |
| The gear motors run very slowly | Check the dip switch setting of the speed adjustment. |
| The Flashing light does not work | Check if the wiring connection of the flashing light is correct. |
| The leaves shall be closed instead of opening | Change the polarity connection of the positive (+) with the negative (-) of the gear motors. |
| The leaves suddenly stop during moving | <ol style="list-style-type: none"> 1. Check if the "RESET" socket is activated. 2. Make sure the wiring connection of the gear motors is firm. 3. Make sure the hall sensor wiring connection is firm. 4. The GND terminal of the photocells on the PCB must be short-circuited if no photocells installed. 5. Make sure the fuse is workable. |
| The leaves does not move or only move toward one direction | <ol style="list-style-type: none"> 1. Check if the "RESET" socket is activated. 2. Make sure the wiring connection of the gear motors is firm. 3. Make sure the hall sensor wiring connection is firm. 4. The GND terminal of the photocells on the PCB must be short-circuited if no photocells installed. |
| The master gate closes to the end first and the slave gate stops, the flashing light blinks fast for five seconds. | Cut off the AC input power and the output of the batteries. Release the master gate and slave gate manually, then open the master to the end and close the slave gate to the end by hand, then power the whole unit by connecting the AC and battery terminals. |
| The gear motors does not run and the relay is noisy when operating the gate opening and closing | Check if the fuse is burned. |